

Machine Screws

Thread Dimensions

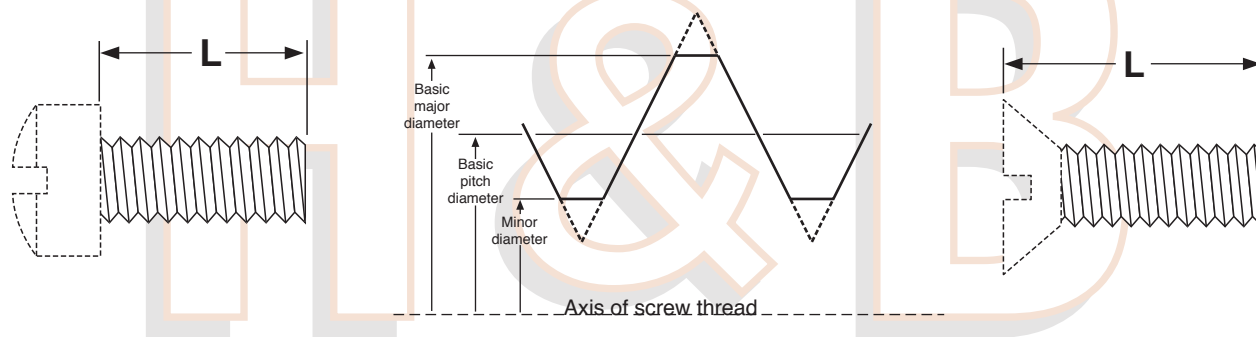

2A EXTERNAL THREADS FOR MACHINE SCREWS AND SEMS

ASME B 1.1 (2002)

Nominal Size & Threads per Inch	Series Designation	Allowance	Major Diameter		Pitch Diameter			Stress Area, in ²	Tensile Strength, ^a lb., min. (STEEL screws only)
			Max	Min	Max	Min	Tolerance		
0-80 0.060	UNF	.0005	.0595	.0563	.0514	.0496	.001762	0.00180	-
1-64 0.073	UNC	.0006	.0724	.0686	.0623	.0603	.001970	0.00263	-
1-72 0.073	UNF	.0006	.0724	.0689	.0634	.0615	.001899	0.00278	-
2-56 0.086	UNC	.0006	.0854	.0813	.0738	.0717	.002127	0.00370	-
2-64 0.086	UNF	.0006	.0854	.0816	.0753	.0733	.002040	0.00394	-
3-48 0.099	UNC	.0007	.0983	.0938	.0848	.0825	.002302	0.00487	-
3-56 0.099	UNF	.0007	.0983	.0942	.0867	.0845	.002191	0.00523	-
4-40 0.112	UNC	.0008	.1112	.1061	.0950	.0925	.002507	0.00604	360
4-48 0.112	UNF	.0007	.1113	.1068	.0978	.0954	.002361	0.00661	396
5-40 0.125	UNC	.0008	.1242	.1191	.1080	.1054	.002562	0.00796	470
5-44 0.125	UNF	.0007	.1243	.1195	.1095	.1070	.002484	0.00830	498
6-32 0.138	UNC	.0008	.1372	.1312	.1169	.1141	.002820	0.00909	550
6-40 0.138	UNF	.0008	.1372	.1321	.1210	.1184	.002614	0.01015	609
8-32 0.164	UNC	.0009	.1631	.1571	.1428	.1399	.002916	0.0140	850
8-36 0.164	UNF	.0008	.1632	.1577	.1452	.1424	.002804	0.01474	884
10-24 0.190	UNC	.0010	.1890	.1818	.1619	.1586	.003319	0.0175	1050
10-32 0.190	UNF	.0009	.1891	.1831	.1688	.1658	.003004	0.0200	1200
12-24 0.216	UNC	.0010	.2150	.2078	.1879	.1845	.003400	0.0242	1450
12-28 0.216	UNF	.0010	.2150	.2085	.1918	.1886	.003224	0.0258	1548
1/4-20 0.250	UNC	.0011	.2489	.2408	.2164	.2127	.003731	0.0318	1900
1/4-28 0.250	UNF	.0010	.2490	.2425	.2258	.2225	.003322	0.0364	2200
5/16-18 0.3125	UNC	.0012	.3113	.3026	.2752	.2712	.004041	0.0524	3150
5/16-24 0.3125	UNF	.0011	.3114	.3042	.2843	.2806	.003660	0.0580	3480
3/8-16 0.375	UNC	.0013	.3737	.3643	.3331	.3287	.004363	0.0775	4650
3/8-24 0.375	UNF	.0011	.3739	.3667	.3468	.3430	.003804	0.0878	5268
1/2-13 0.500	UNC	.0015	.4985	.4876	.4485	.4435	.004965	0.1419	8500
1/2-20 0.500	UNF	.0013	.4987	.4906	.4662	.4619	.004288	0.1599	9594
Tolerance on Length L	Nominal Screw Size	Nominal Screw Length							
		Up to 1/2 in., incl.	Over 1/2 to 1 in., incl.	Over 1 to 2 in., incl.	Over 2 in.				
	0 thru 12	-0.02	-0.03	-0.06	-0.09				
1/4 thru 3/4	-0.03	-0.03	-0.06	-0.09					

^aTensile strength values are based on 60,000 psi. and apply to carbon steel screws and SEMS only. Hex and Hex Washer head machine screws of sufficient length may be wedge tensile tested. Other head styles may be axial tensile tested.

MACHINE SCREWS WITH FREE-SPINNING LOCKWASHERS

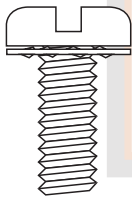

Internal Tooth

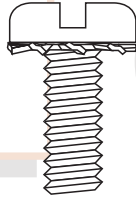

External Tooth

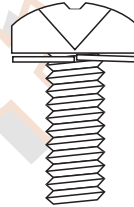

Split-Lock

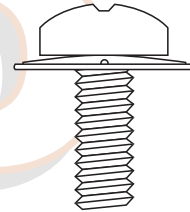

Square-Cone®

Description	A machine screw and free-spinning lock-washer manufactured as one assembly. Steel SEMS are available with the following types of washers: internal tooth, external tooth, split-lock and square-cone®. Stainless SEMS are offered with external tooth lock washers.
Applications/ Advantages	The washer/screw assembly makes this a locking screw with the washer providing the locking action. Machine pre-assembly provides cost savings to the end user. Internal Tooth SEMS: Recommended when it is desirable to hide the teeth for appearance or to prevent snagging. External Tooth SEMS: Preferred over the internal tooth style as the teeth provide greater torsional resistance being on the larger radius. Split-Lock SEMS: Preferred over tooth lockwasher SEMS for use with hardened bearing surfaces. Square-Cone® SEMS: Provides a higher retained clamp load & improved compensation for thermal cycling and vibration. Can accept a high tension load and maintain spring action. The washer design makes for better control during installation, and improved tool bit life. Ideal for clamping fragile materials and for spanning large clearance holes.
Material	Steel Screws-- AISI 1022 or equivalent steel. Steel Washers-- Split-lock: SAE 1055-1065 carbon steel; Tooth-lock: SAE 1050-1065; Square-Cone®: SAE 1050. Stainless Screws-- SAE 18-8 stainless steel or 410 martensitic stainless steel Stainless Washers-- Split-lock: SAE J405 302-305; Tooth-lock: SAE 410 stainless steel; Square-Cone®: 18-8 stainless steel
Hardness	Steel Screws-- Rockwell B70 - B100. Steel Washers-- Split-lock: Rockwell C38 - 46; Tooth-lock: Rockwell C40 - 50; Square-Cone®: Rockwell C42 - 46. Stainless Washers-- Split-lock: Rockwell C35 - 43; Tooth-lock: Rockwell C40 - 50; Square-Cone®: Rockwell B88 minimum.
Tensile Strength	Steel: 60,000 psi. minimum. No. 2 diameter SEMS screws are not subject to tensile testing. No. 4 SEMS screws shorter than 1/2" are not subject to tensile testing. SEMS screws of diameters No. 6 to 10 inclusive, which are shorter than 1/2" or 3D (where D is the nominal screw size in inches) are not subject to tensile testing. Such SEMS screws of a size to be tested shall meet the tensile load requirements given on page 78. 18-8 Stainless: No. 4: 99,000 psi. minimum; No. 6 & No. 8: 96,000 psi. minimum. Note: No. 4, No. 6 and No. 8 SEMS screws which are shorter than 1/2" are not subject to tensile testing. 410 Stainless: No. 4, No. 6 and No. 8 SEMS screws which are shorter than 1/2" are not subject to tensile testing.
Plating	See Appendix-A for information on the plating of steel SEMS.

HOW SEMS SPECIFICATIONS VARY FROM MACHINE SCREWS

- The maximum diameter of the unthreaded shank shall be less than the maximum major diameter of the thread by an amount sufficient to prevent disassembly of the washer from the screw.
- The unthreaded length on full threaded screws is measured to the contacting face of the washer instead of to the bearing face of the screw.
- The minimum underhead fillet radius is equivalent to 5% of the basic screw diameter.

Tooth-lock, Split & Conical

SEMS Washer Specs for Pan Head Screws

Machine Screws



TOOTH-LOCK WASHERS FOR PAN HEAD SEMS

ASME B18.13-1996

Nominal Size or Basic Screw Diameter		Internal Tooth				External Tooth			
		Washer Thickness		Washer Outside Diameter		Washer Thickness		Washer Outside Diameter	
		Max	Min	Max	Min	Max	Min	Max	Min
2	.0860	.016	.010	.185	.175	.016	.010	.180	.170
4	.1120	.018	.012	.268	.258	.018	.012	.230	.220
6	.1380	.022	.016	.288	.278	.022	.016	.285	.270
8	.1640	.023	.018	.338	.327	.023	.018	.320	.305
10	.1900	.024	.018	.383	.372	.024	.018	.381	.365
12	.2160	.027	.020	.408	.396	.027	.020	.410	.395
1/4	.2500	.028	.023	.478	.466	.028	.023	.510	.494

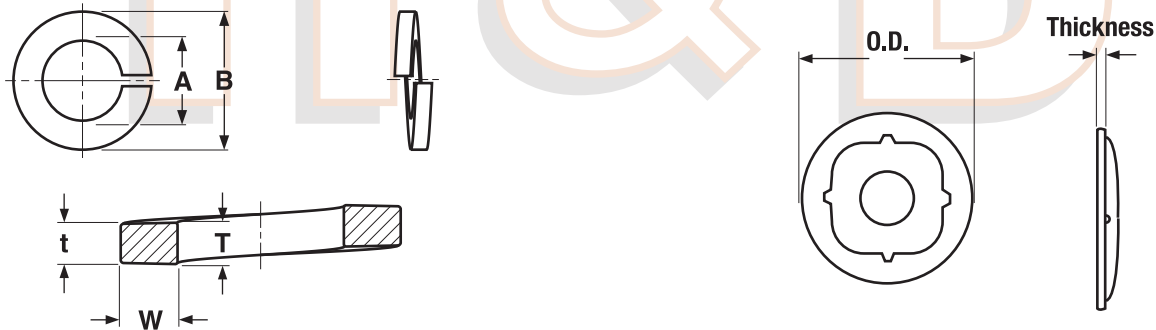

WASHERS FOR SPLIT-LOCK & SQUARE-CONE® PAN HEAD SEMS

ASME B18.13,-1996
Shakeproof*

Nominal Size or Basic Screw Diameter		Split-Lock				Square Cone®*				
		Washer Outside Diameter A		Washer Section Min		Washer Outside Diameter B		Washer Thickness	Washer Outside Diameter	
		Max	Min	Width W	Thickness $\frac{T+t}{2}$	Max	Min	Ref	Max	Min
2	.0860	.080	.075	.035	.020	.156	.145	.015	.210	.200
4	.1120	.106	.101	.055	.034	.222	.211	.015	.250	.244
6	.1380	.129	.124	.062	.034	.261	.248	.025	.320	.307
8	.1640	.155	.149	.078	.040	.319	.305	.030	.383	.370
10	.1900	.179	.173	.093	.047	.373	.359	.032	.446	.433
1/4	.2500	.238	.230	.125	.062	.496	.480	.039	.508	.495

*Dimensions of Square-Cone® washers are to Shakeproof specifications. Square-Cone® is a registered trademark of Shakeproof division of Illinois Tool Works.

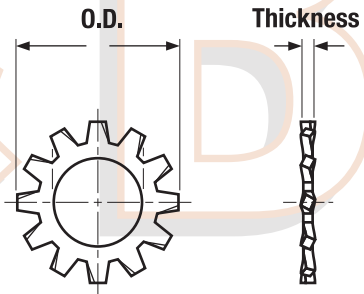
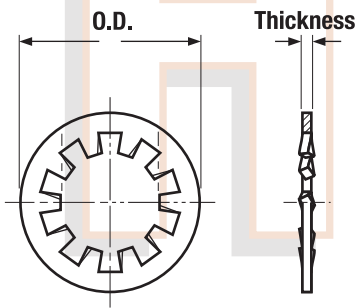

TOOTH LOCK WASHERS FOR HEX HEAD SEMS										ASME B18.13-1996
Nominal Size or Basic Screw Diameter		Internal Tooth				External Tooth				
		Washer Thickness		Washer Outside Diameter		Washer Thickness		Washer Outside Diameter		
		Max	Min	Max	Min	Max	Min	Max	Min	
4	.1120	.018	.012	.268	.258	.018	.012	.230	.220	
6	.1380	.022	.016	.288	.278	.022	.016	.285	.278	
8	.1640	.023	.018	.338	.327	.023	.018	.320	.305	
10	.1900	.024	.018	.383	.372	.024	.018	.381	.365	
12	.2160	.027	.020	.408	.396	.027	.020	.410	.395	
1/4	.2500	.028	.023	.478	.466	.028	.023	.475	.460	
5/16	.3125	.034	.028	.610	.597	.034	.028	.580	.567	
3/8	.3750	.040	.032	.692	.678	.040	.032	.660	.640	

TOOTH LOCK WASHERS FOR HEX WASHER HEAD SEMS										ASME B18.13-1996
Nominal Size or Basic Screw Diameter		Internal Tooth				External Tooth				
		Washer Thickness		Washer Outside Diameter		Washer Thickness		Washer Outside Diameter		
		Max	Min	Max	Min	Max	Min	Max	Min	
4	.1120	-	-	-	-	.018	.012	.230	.220	
6	.1380	.022	.016	.288	.278	.022	.016	.317	.306	
8	.1640	.023	.018	.338	.327	.023	.018	.317	.306	
10	.1900	.024	.018	.383	.372	.024	.018	.406	.395	
12	.2160	.027	.020	.408	.396	.027	.020	.406	.395	
1/4	.2500	.028	.023	.478	.466	.028	.023	.580	.567	
5/16	.3125	.034	.028	.610	.597	.034	.028	.654	.640	
3/8	.3750	.040	.032	.692	.678	.040	.032	.760	.740	